

Not Recommended for New Projects

Features

- Efficiency up to 94%, Non isolated, no need for heatsinks
- SMD Package (UL94V-0 Material)
- Adjustable Output Voltage
- Short circuit protection, Thermal shutdown
- Remote On/Off Control
- Very Low Shutdown Current

Description

The R-78Axx-1.0SMD series high efficiency switching regulators are ideally suited to pick-and-place mass production. The efficiency of up to 94% means that very little energy is wasted as heat. remote on/off control and adjustable output voltage are useful additional features of this versatile SMD converter series.

Selection Guide

Part Number SMD	Input Range (1) (V)	Output Voltage (V)	Adjust Range (V)	Output Current (A)	Efficiency	
					Min. Vin (%)	Max. Vin (%)
R-78A1.8-1.0SMD	4.75 – 18	1.8	1.5~3.3	1.0	82	71
R-78A2.5-1.0SMD	4.75 – 18	2.5	1.5~4.5	1.0	87	77
R-78A3.3-1.0SMD	4.75 – 18	3.3	1.8~5.5	1.0	91	81
R-78A5.0-1.0SMD	6.5 – 18	5.0	2.5~5.5	1.0	94	86

Specifications (typical at 25°C, 10% minimum load, unless otherwise specified)

Characteristics	Conditions	Min.	Typ.	Max.
Input Voltage Range	See Table	4.75V		18.0V
Output Voltage Range	See Table	1.5V		5.5V
Output Current	All Series	0mA*		1000mA
Output Current Limit	All Series			3000mA
Short Circuit Input Current (Vin = 12V)	All Series			100mA
Internal Power Dissipation				0.4W
Short Circuit Protection		Continuous, automatic recovery		
Output Voltage Accuracy (At 100% Load)	All Series		±2%	±3%
Adjustable Voltage Range	See Table 1			±50%
Line Voltage Regulation (Vin = min to max at full load)			0.2%	0.4%
Load Regulation (10% to 100% full load)			0.7%	1.0%
Dynamic Load Stability	100% <-> 50% load		±85mV	±100mV
Ripple & Noise (20MHz BW)			20mVp-p	30mVp-p
Temperature Coefficient	-40°C~+85°C ambient			0.015%/°C
Max capacitance Load				220µF
Switching Frequency		280kHz	350kHz	430kHz
Quiescent Current	Vin = min. to max. at 0% load		5mA	7mA
ON/OFF Remote Control Pin Drive Current			Ir=1.8µA typ	
Converter Input Current (valid for Vr < 1.6V)			20µA	35µA
Remote On/Off Threshold Voltage (Vr rising)		2.4V	2.6V	2.8V
Remote On/Off Voltage Hysteresis			250mV	
Operating Temperature Range		-40°C		+85°C
Switch On/Off Time	(using Remote On/Off Control)			50ms
Operating Case Temperature				+100°C
Storage Temperature Range		-55°C		+125°C
Case Thermal Impedance			70°C / W	
Thermal Shutdown	Internal IC junction			+160°C

cont.

INNOLINE
DC/DC-Converter

RECOM

1.0 AMP
SMD
Single Output

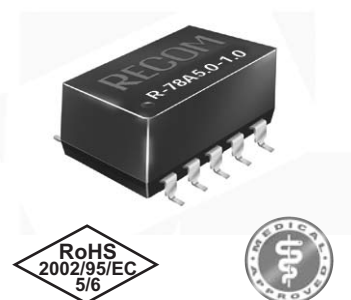

EN-55022 Certified
EN-55024 Certified
EN-60601-1-2 Certified
EN-60950-1 Certified

R-78A-1.0

Derating-Graph (Ambient Temperature)

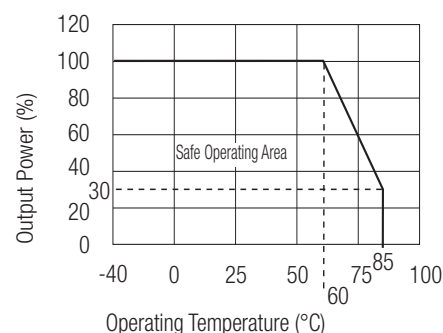

R-78Axx-1.0 SMD Series

INNOLINE
DC/DC-Converter

Standard Application Circuit

EMC	Conducted Emissions	EN55022	Class B
	Radiated Emissions	EN55022	Class B
	ESD	EN61000-4-2	Class A
	Radiated Immunity	EN61000-4-3	Class A
	Fast Transient	EN61000-4-4	Class A
	Conducted Immunity	EN61000-4-6	Class A
	Magnetic Field Immunity	EN61000-4-8	Class A
Safety Certification			EN-60950-1
Package Weight		2.7g	
Packing Quantity			33 pcs per Tube 250 pcs per Reel
MTBF (+25°C)	Detailed Information see Application Notes chapter "MTBF"		13338 x 10 ³ hours
(+71°C)		using MIL-HDBK 217F	3880 x 10 ³ hours

*Note: Operation under no load will not damage these devices, however they may not meet all specifications. A minimum load of 10mA is recommended

Characteristics

Efficiency

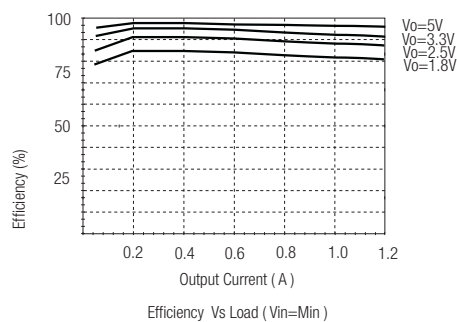
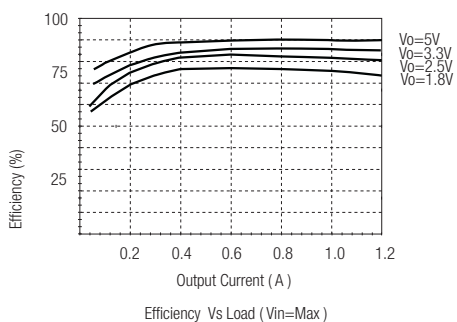
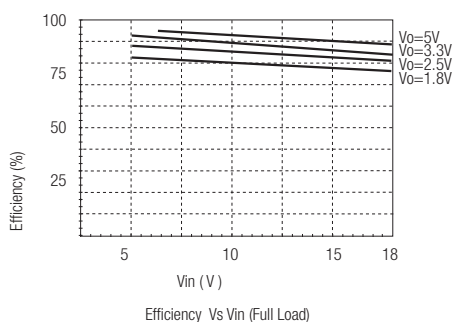

Ripple

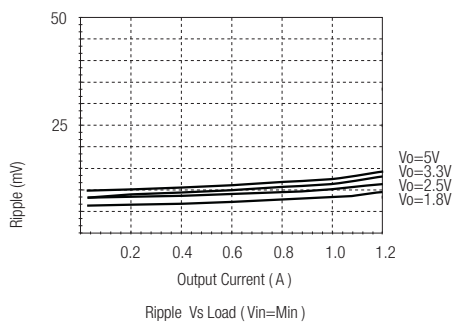
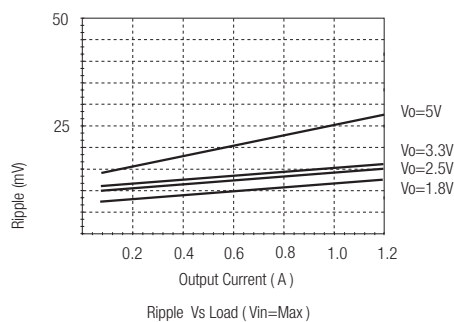
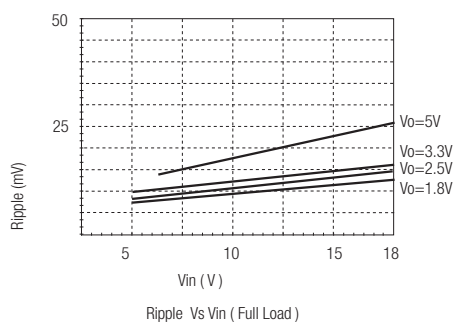

R-78Axx-1.0 SMD Series

INNOLINE
DC/DC-Converter

Standard Application Circuit

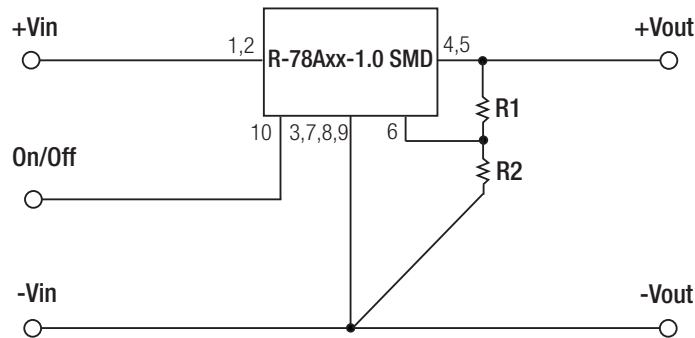

IMPORTANT INFORMATION: The R-78Ax.x.xSMD series are not suitable to be soldered using vapour phase soldering, they are only guaranteed to be safe in IR or convection reflow ovens and by hand soldering. Reflow conditions should not exceed the limits of the Jedec STD-020C profile. This restriction applies to the product series R-78Ax.x-0.5SMD, R-78Ax.x-1.0SMD and RCD-24B-0.70/SMD only and does not affect any other RECOM products. For more details regarding this matter please contact info@recom-development.at

Application Examples

3.3V/5V Selectable 1A Power Supply

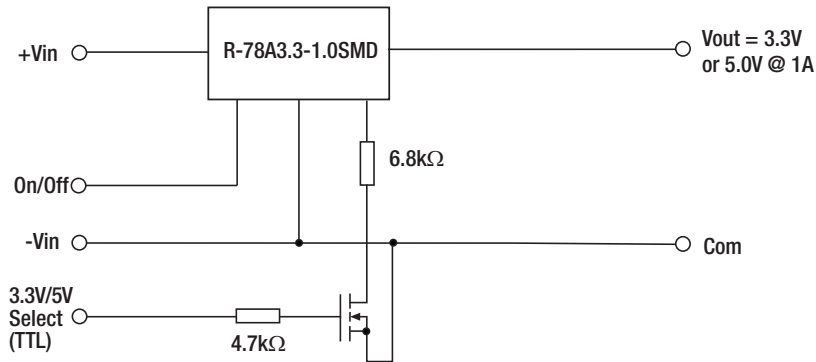

R-78A-1.0

Optional Protection Circuit

Optional Protection 1:

Add a blocking diode to Vout if current can flow backwards into the output, as this can damage the converter when it is powered down.

The diode can either be fitted across the device if the source is low impedance or fitted in series with the output (recommended).

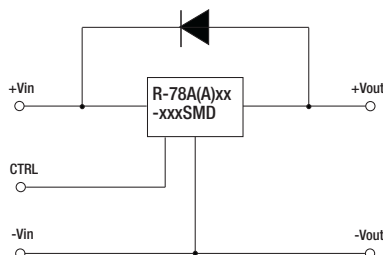

Optional Protection 2:

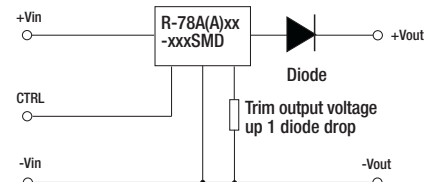

R-78Axx-1.0 SMD Series

INNOLINE
DC/DC-Converter

Table 1: Adjustment Resistor Values

1.0A _{dc}	R-78A1.8-1.0SMD		R-78A2.5-1.0SMD		R-78A3.3-1.0SMD		R-78A5.0-1.0SMD	
V _{out} (nom.)	1.8V _{dc}		2.5V _{dc}		3.3V _{dc}		5.0V _{dc}	
V _{out} (adj)	R1	R2	R1	R2	R1	R2	R1	R2
1.5 (V)	3K Ω		200 Ω					
1.8 (V)			12K Ω					
2.5 (V)		11.8K Ω						
3.0 (V)		4.64K Ω		44.2K Ω	88.4K Ω		17K Ω	
3.3 (V)							27K Ω	
3.6 (V)						60.4K Ω	42K Ω	
3.9 (V)						28K Ω	58K Ω	
4.5 (V)						11.3K Ω	180K Ω	
4.9 (V)						7.15K Ω	850K Ω	
5.0 (V)						6.34K Ω		
5.1 (V)						5.9K Ω		231K Ω
5.5 (V)						3.9k Ω		56.2K Ω

Package Style and Pinning (mm)

R-78A-1.0



SMD 10Pin Package

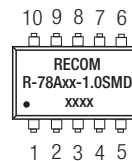
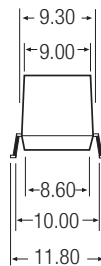
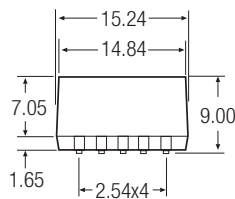

Pin Connections

Pin #	Connection
1,2	+Vin
3,7,8,9	GND
4,5	+Vout
6	V adj
10	Remote On/Off

xx.x ± 0.5 mm
xx.xx ± 0.25 mm

Recommended Footprint Details

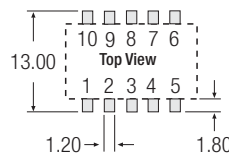
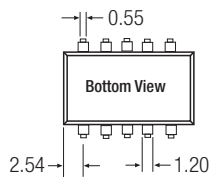

* add suffix -R for tape & reel packing e.g. R-78A5.0-1.0-R. For more details see Application Notes